

产品规格书

Product Specification

编号 No.: _____
版本 Version: A0
总页数 Pages: 11
发出日期 Issued on: 2019-01-26

客户名称 Customer: _____
客户部件号 Customer Part No.: _____
冠泰产品名称 Greetech Product Name: Micro Switch
冠泰产品型号 Greetech Item No.: G303U-130W00A1

规格书确认 Specification For Approval

确认者 Approval by

签名或盖章 Signature: _____ 日期 Date: _____

备注:

- 该规格书为客户与冠泰公司产品在技术方面的共识，其它相关数据上与该规格书不一致的内容都是无效的。
This Product Specification is considered as the technical agreement on product between the receiving customer and greetech. Any information on the Product Catalogue which is in conflict with or different from the corresponding information of this document is considered as invalid.
- 如果顾客收到规格书后没有信息反馈而直接向我公司订货，我们将认为贵客已接受此规格书。
If customer issue purchase orders without confirmation by signature of this specification after receipt, such confirmation will be considered as granted upon receipt of the first purchase order.
- 本产品规格书从生效日起1年后，如果没有订货返回或再次申请最新规格书时请作无效处理。
If there is no order or no request for new specification after 1 year upon this specification is issued, the specification will be regarded as invalid.

若确认此规格书，请签复此页。Please return this copy as a certification of your approval.

规格书更改记录 Record of Changing Specification

规格书项 Item of Spec.		规格书项 Item of Spec.	
更改前 Before Change		更改前 Before Change	
更改后 After Change		更改后 After Change	
查询编号 Enquiry Ref. #		查询编号 Enquiry Ref. #	

地址: 广东省惠州市惠城区陈江镇大欣集团第三区
Address: 3RD. DIST., TAHSIN GROUP, CHENJIANGTOWN, HUICHEN ZONE, HUIZHOU CITY, GUANGDONG PROVINCE, CHINA
电话 Tel: +86. 752-5855486
传真 Fax: +86. 752-5855496
电子邮箱 E-Mail: sales@greetech.com
网址 Website: www.greetech-switch.com



拟制 Prepared by: Jiahui Xu
审核 Checked by: Mao
核准 Apprved by: Luke Lu

产品型号 Item. #	G303U-130W00A1	说明 Description	微动开关 Micro Switch	版本 Version	A0
页 码 Page	第 2 页 2 of 10		日期 Date	2019-01-26	

1. 一般特性 General Characteristics:

1.1 适用范围 Application	该规格书指微动开关的一般使用范围 This specification is applied to the micro switch for general applications.
1.2 使用温度范围 Operating Temperature Range	-40° C to +85° C
1.3 使用相对湿度范围 Operating Relative Humidity Range	≦96% RH, +40° C
1.4 实验条件 Test Conditions	若没有特别说明, 则试验大气条件如下: Unless otherwise specified, the atmospheric conditions for making measurements and tests are as follows: 环境温度 Ambient Temperature: 5-35° C 大气压力 Air Pressure: 86-106 Kpa 相对湿度 Relative Humidity: 45-85% RH

2. 外观, 结构及尺寸 Appearance, Structure and Dimensions:

2.1 外观 Appearance	产品外观良好, 无锈蚀、裂纹和镀层缺陷。 The switch shall have good finishing, and no rust, crack or plating defects.
2.2 结构及尺寸 Structure and Dimensions	参见产品图纸 Refer to individual product drawing
2.3 标识 Markings	参见产品图纸 Refer to individual product drawing
2.4 保护等级 Degree of Protection.	IEC IP67 (不包括外漏端子部分) IEC IP67(Excluding the terminals on terminal models)

3. 额定负荷及寿命 Ratings and Life:

额定负荷 Ratings	机械寿命 Operating life without load	负荷寿命 Operating life with load
参见产品图纸 Refer to individual product drawing	参见 6.1 项 Refer to 6.1 item	参见 6.2 项 Refer to 6.2 item

4. 电气性能 Electrical Characteristics:

项目 Item	标准 Criteria	实验方法 Test Method
4.1 绝缘电阻 Insulation Resistance	100MΩ Min.	在相互绝缘的所有端子之间及各接线端子与外露的非载流金属零件之间加载 500V 直流电, 持续时间 60 ± 5 秒。 500V DC voltage is applied between each pair of terminals, and between the terminal and the metal frame for 60 ± 5 Sec.
4.2 抗电强度 Dielectric Voltage	无击穿现象发生 No dielectric breakdown shall occur	在相互绝缘的所有接线端子之间加载 500V(50-60Hz, 泄漏电流 10mA)交流电, 各接线端子与外壳或非载流金属零件之间加载 1000V(50-60Hz, 泄漏电流 10mA)交流电, 持续时间 60±5 秒。 500V(50-60HZ, 10mA)alternate current load is applied between open terminals connected with wires; or 1000V(50-60HZ, 10mA) alternate current load is applied between frame and terminal or between metal parts, for 60 ± 5 Sec.

产品型号 Item.#	G303U-130W00A1	说明 Description	微动开关 Micro Switch	版本 Version	A0
页 码 Page	第 3 页 3 of 10		日期 Date	2019-01-26	

5. 机械性能 Mechanical Characteristics:

项目 Item	标准 Criteria	实验方法 Test Method
5.1 操作力 Operating Force	参见产品图纸 Refer to individual product drawing	在操作元件末端沿操作方向均匀施加静载荷, 使操作元件转换到动作位置 A static load shall be applied to the tip of actuator in operating direction to change the component to operating position
5.2 回复力 Releasing Force	参见产品图纸 Refer to individual product drawing	在操作元件末端沿操作方向均匀减少静载荷, 使操作元件从动作位置转换到释放位置。 A static load shall be reduced to the tip of actuator in operating direction to change component from operating position to release position.
5.3 操作位置 Operating Position	参见产品图纸 Refer to individual product drawing	开关发生转换时, 操作元件末端到开关安装孔中心的距离 The distance from the end of operating component to the center of mount hole when switch is being transformed
5.4 预行程 Pre-travel	参见产品图纸 Refer to individual product drawing	从自由位置到动作位置的距离。 The distance from release position to operating position
5.5 差程 Differential Travel	参见产品图纸 Refer to individual product drawing	从动作位置到释放位置的距离。 The distance from operating position to release position
5.6 超行程 Over travel	参见产品图纸 Refer to individual product drawing	驱动件从动作位置到全行程位置间的位移。 The displacements of actuator form operation to total travel position.
5.7 接线端强度 Terminal Strength	端子无松动, 损坏及绝缘层的破裂 Shall be free from terminal looseness, damage and insulator breakage. 电气性能应符合第 4.1, 4.2 的要求 The electrical performance Requirements specified in Section 4.1, 4.2 be satisfied.	以 1255gf/12N 作用力沿轴向逐渐施加于接线端末端, 作用力方向为离开开关向外指向, 保持 60 秒, 每个接线端子测量一次。 A static load of 1255gf/12N shall be applied to the tip of terminal in a desired direction for 60 Sec. The test shall be done once per terminal.
5.8 操作件强度 Actuator strength	将下面的力施加在操作件上无电性能和机械性能不良 No electrical or mechanical defect after the following force is applied to the actuator 方向: 操作件的操作方向 Direction: Actuator operation direction 力度: 规定的力度 (OF), 0.5 kgf Force: the specified operating force (OF), 0.5 kgf. 时间: 一分钟一次(总共 10 次) Time: 1 times of 1 minute. (10 times in total)	

产品型号 Item.#	G303U-130W00A1	说明 Description	微动开关 Micro Switch	版本 Version	A0
页 码 Page	第 4 页 4 of 10		日期 Date	2019-01-26	

6. 寿命试验 Durability Characteristics:

	项目 Item	标准 Criteria	实验方法 Test Method
6.1	机械寿命 Operating Life without Load	实验后 After test: 绝缘电阻: 10M Ω Min Insulation resistance: 10M Ω Min	在不带负荷的条件下, 在寿命试验设备上连续转换 500,000 次, 30-60 次 /分钟。 500,000 cycles of operation shall be performed continuously at a rate of 30-60 cycles per minute without load.
6.2	负荷寿命 Operating Life with Load	抗电强度: AC 500V 60 \pm 5 秒 Withstand voltage AC 500V, 60 \pm 5Sec 开关外观及结构应无损坏 The switch shall be free from abnormalities in appearance and construction.	在产品图纸标示负荷的条件下, 在寿命试验设备上连续 100,000 次, 15 次/分。 100,000 cycles of operation shall be performed continuously at a rate of 15 cycles per minute with load as follow: Refer to individual product drawing (Resistive Load)

7. 耐候性能 Weather Proof Characteristics:

	项目 Item	标准 Criteria	实验方法 Test Method
7.1	低温 Cold Proof	实验后 After test: 绝缘电阻: 10M Ω Min Insulation resistance: 10M Ω Min 抗电强度: AC 500V 60 \pm 5 秒 Withstand voltage AC 500V, 60 \pm 5Sec	试件在 $-40\pm 3^{\circ}$ C 的温控箱内保持 96 小时, 然后在正常温度和湿度下恢复 2 小时, 并在此后 1 小时内对试品进行测量, 水滴应消失。 After testing at $-40\pm 3^{\circ}$ C for 96 hours, the switch can stay under normal temperature and humidity conditions for 2 hours, and measurement shall be made within 1 hour after that. Water drops shall be eliminated.
7.2	高温 Hot Proof	开关外观及结构应无损坏 The switch shall be free from abnormalities in appearance and construction.	试件在 $85\pm 2^{\circ}$ C 的温控箱内保持 96 小时, 然后在正常温度和湿度下恢复 2 小时, 并在此后 1 小时内对试品进行测量。 After testing at $85\pm 2^{\circ}$ C for 96 hours, the switch can stay under normal temperature and humidity conditions for 2 hours and measurement shall be made within 1 hour after that.
7.3	恒定湿热 Moisture Resistance		试件在 $40\pm 2^{\circ}$ C, 90-95%RH 的温控箱内保持 96 小时, 然后在正常温度和湿度下恢复 2 小时, 并在此后 1 小时内对试件进行测量, 水滴应消失。 After testing at $40\pm 2^{\circ}$ C, 90-95% RH for 96 hours, the switch can stay under normal temperature and humidity conditions for 2 hours, and measurement shall be made within 1 hour after that. Water drops shall be eliminated.

产品型号 Item. #	G303U-130W00A1	说明 Description	微动开关 Micro Switch	版本 Version	A0
页 码 Page	第 5 页 5 of 10		日期 Date	2019-01-26	

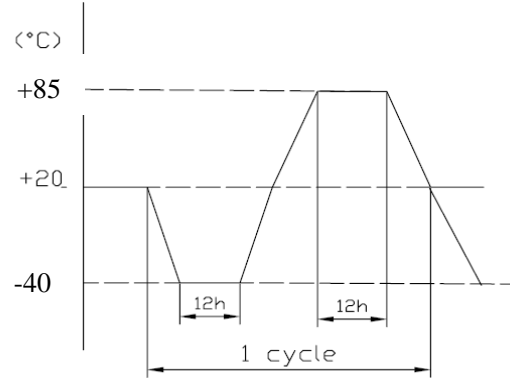
7.4	温度转换 Temperature Cycling		<p>试件按下述实验条件试验 5 个循环，然后在正常温度和湿度下恢复 2 小时，并在此后 1 小时内对试品进行测量，水滴应消失。</p> <p>After 5 cycles of following conditions, the switch can stay under normal temperature and humidity conditions for 2 hours, and measurement shall be made within 1 hour after that. Water drops shall be eliminated.</p> 									
7.5	耐焊接热 Solder Resistance	<p>实验后 After test:</p> <ol style="list-style-type: none"> 功能和结构 Function and construction 抗电强度 Dielectric Strength <ol style="list-style-type: none"> At 500 VAC/minute, can not breaking between Live Part. At 1000 VAC/minute, can not breaking between Live Part and Frame. 绝缘电阻 Insulation Resistance At 500VDC/minute Insulation Resistance >100MΩ 	<p>开关在按下列条件试验后进行检查</p> <p>The switch shall be checked after being tested under the following conditions.</p> <p>温度和浸渍时间 Temperature and soaking time.</p> <table border="1" data-bbox="813 1164 1468 1388"> <thead> <tr> <th>试验方法 Test method</th> <th>Temperature (°C)</th> <th>Time (S)</th> </tr> </thead> <tbody> <tr> <td>焊槽法 Welding groove method</td> <td>260±5</td> <td>5±1</td> </tr> <tr> <td>烙铁法 Soldering iron method</td> <td>350±5</td> <td>3±0.5</td> </tr> </tbody> </table>	试验方法 Test method	Temperature (°C)	Time (S)	焊槽法 Welding groove method	260±5	5±1	烙铁法 Soldering iron method	350±5	3±0.5
试验方法 Test method	Temperature (°C)	Time (S)										
焊槽法 Welding groove method	260±5	5±1										
烙铁法 Soldering iron method	350±5	3±0.5										

8. 开关材料表 BOM:

序号 No.	零部件名称 Parts Name	数量 Quantity	材料, 规格 Material and Specifications	备注 Remarks
1	胶盖 Cover	1	PA	
2	胶壳 Case	1	PA	
3	按挚 Plunger	1	POM	
4	COM 端子 COM Terminal	1	Cu Alloy	Ag-PLATED
5	弹簧 Spring	1	SWC	
6	动片 Moving Plate	1	Cu Alloy	Ag-PLATED
7	支杆 Internal lever	1	Stainless Steel	
8	公共端子触点 COM Contact	2	Ag Alloy	
9	端子触点 Terminal Contact	2	Ag Alloy	
10	NO 端子 NO Terminal	1	Cu Alloy	Ag-PLATED
11	NC 端子 NC Terminal	1	Cu Alloy	Ag-PLATED
12	密封圈 Sealed Circle	1	Silicone Rubber	
13	密封胶水 airproof gluewater	0.1g	Epoxy resin	

产品型号 Item.#	G303U-130W00A1	说明 Description	微动开关 Micro Switch	版本 Version	A0
页 码 Page	第 6 页 6 of 10		日期 Date	2019-01-26	
14	密封圈胶水 Ealed Circle gluewater	0.007g	Silicon glue		

注意事项 Precautions for use:

1. 一般事项 General:

本产品主要用于自动化装置，视像装置，家用电器，信息装置及通讯装置等常用电子设备中；如果该产品要用于其它具有更高安全性及可靠性的耐久性设备中（如生命维持装置，宇宙航空装置，防灾及安全性装置）时，请确认是否合用，或者同我方了解详细情况。

The product is used mainly in electronic devices such as automotive devices, visual devices, home electrical appliances, information devices and communication settings. If the products is intended to be used for other endurance equipments requiring higher safety and reliability such as life support system, space and aviation devices, disaster and safety system, it' s necessary to make verification of conformity or contact us for the details before using.

2. 焊接安装 Soldering and assembly:

(1) 焊锡条件应按照实际的对应条件予以确认。

The soldering conditions should be confirmed according to the actual production environment.

(2) 焊锡工序完成后，不要尝试用溶剂或类似物品清洗开关。

Don' t try to clean the switch with a solvent or similar substance after the soldering process.

(3) 开关焊锡后，还有热量时，请不要操作开关。

Don' t operate the switch if it still has heat after soldering.

(4) 如使用水溶性助焊剂，可能会导致开关破损，因此应确保不要用这种助焊剂。

The switch might be damaged if using the water-soluble flux, so make sure not to use such kind of flux.

(5) 当焊接端子导线时，首先将导线插入端子孔并进行焊接。

When soldering the lead wire to the terminal, first insert the lead wire conductor through the terminal hole and then conduct soldering.

(6) 确保电烙铁的功率最大为 30 W。注意开关端子焊接不能超过 3s。

Made sure that the capacity of the soldering iron is 30 W maximum. Do not take more than 3 s to solder the switch terminal.

(7) 过高的焊锡温度或过长的焊锡时间会使开关的性能下降。

Improper soldering involving an excessively high temperature or excessive soldering time may deteriorate the characteristics of the Switch.

(8) 当焊接 PCB 端子导线时应特别注意不能因焊锡不平整而超过 PCB 端子平面。

When soldering the lead wire to the PCB terminal, pay careful attention so that the flux and solder liquid level does not exceed the PCB level.

3. 安装构造，机械设计 Assembly structure and Mechanical design:

(1) 线路板上安装孔及安装图示的尺寸都须参照工程图中所建议的尺寸。

The dimensions for the holes and the pattern on PCB should refer to the recommended dimensions on the engineering drawing.

(2) 如果施超出规定值的较大重力于开关上，会导致开关破损，所以应特别小心防止开关承受超出规定值的较大重力。

The switch might be broken if there is stress stronger than the specified is given on it. Take special care not to stress the switch beyond its specification.

(3) 把本公司的产品和其它产品配合使用时，请客户确认必须适合的规格、法规或规定。另请客户自身确认本公司产品装到客户使用的系统、机械、装置上的适用性。如果想变更开关使用条件，请预先与本公司进行协商。

If the switch is being used together other products, please confirm the compatibility of the specification, laws and regulations. Please also confirm the compatibility of switch to be installed in the systems, machines and devices used by customer. If you want to change the operating conditions of the switch, please consult with us in advance.

产品型号 Item.#	G303U-130W00A1	说明 Description	微动开关 Micro Switch	版本 Version	A0
页 码 Page	第 7 页 7 of 10		日期 Date	2019-01-26	

4. 使用环境 Operating Environment

(1) 如果该产品常用于产生硫化气体的硫性热源周围或有汽车废气存在的地方，应特别留意，因为开关性能可能会受到影响；

If the product is always used near sulfurate hot spring where sulfide gas is generated or in a place where exhaust gas from automobiles exists, it's necessary to pay more attention because the switch performance may be affected.

(2) 如果在安装开关的模组内有以下所描述的部件材料，需遵循以下要求：

If the below parts or materials are used in the module where the switch is installed, directions below should be followed:

A. 部品、橡胶材料、粘合剂、包装材料及用于装置内机械部件上的润滑油剂等，不要使用那些可能会产生硫化气体或氧化气体的材料。

For parts, rubber materials, adhesive agents, packing material and grease used for the mechanical part of the device, don't use any material that may generate gas of sulfurization or oxidization.

B. 当有用到磷橡胶、润滑油、粘合剂及油脂时，应使用不会产生低分子磷氧烷气体的材料，因为低分子磷氧烷气体会在开关接触部位形成二氧化磷层而引起接触不良，如有用到（如涂料剂等化学溶剂），请预先告知我方。If silicon rubber, grease, adhesive agents and oil are used, choose the material that will not generate low molecular siloxane gas, because the low molecular siloxane gas may form silicon dioxide coat on the switch contact part, resulting of failing contact.

(3) 不要将开关用于高湿或有沾湿可能性的环境中，因这样的环境可能会引起端子间电流泄漏。

Don't use the switch in the environment with high humidity or other bedewing possibility, as it may cause leaking among the terminals.

5. 保存方法 Storage Method:

(1) 为防止本产品的性能劣化和耐焊性等性能受到影响，请保管在以下的条件和环境下：

In order to protect the switch performance and the soldering conditions, it should keep the switch under the following conditions:

A. 温度 -10°C 以上，+40°C 以下，湿度 85% 以下的环境。

Temperature of -10°C to +40°C, with humidity lower than 85RH;

B. 避免保存在含有腐蚀性气体等的空气中。

Avoid storing in the environment containing corrosive gas;

C. 产品购入后长期保管不可超过 6 个月以上。

After purchasing, the storage period should not exceed 6 months.

D. 避免保存在日光能直射的场所。

Avoid keeping it in the location with direct sunlight.

(2) 在不施加负重外力的包装状态下进行保管。

Store using the standard packing without exerting force.

(3) 保存标准为 3 个月，限度为 6 个月以内，请尽早使用。打开包装后，有剩余品时，应将剩余部分以胶袋包装好以同外界隔离，请进行合适的防湿，防腐蚀气体等处理后进行保管。

The standard storage period is 3 months, with maximum up to 6 months, preferably to be used as soon as possible. After opening the package, you should put the remaining switches in a plastic bag to prevent from damp and corrosive gas.

6. 关于保护构造 Degree of Protection

请勿在水中使用时。导线型虽然对下述规定，满足试验条件，但这些试验是在水中放置一段时间后确定进水程度的试验，并非在水中开闭动作的试验。

Do not use this product in water. Although molded lead wire models satisfy the test conditions for the standard given below, this test is to check the ingress of water into the switch enclosure after submerging the Switch in water for a given time.

产品型号 Item. #	G303U-130W00A1	说明 Description	微动开关 Micro Switch	版本 Version	A0
页 码 Page	第 8 页 8 of 10		日期 Date	2019-01-26	

Satisfying this test condition does not mean that the Switch can be used in water.

a) 通过外壳的保护构造的分类等级，IP67 保护等级。

IEC Publication 529, degree of protection IP67.

b) 当处于经常有水滴的状态，以及处于带水状态下的开闭、还有在温度急剧变化的情况下由于冷凝，都可能发生水分浸入开关内部的情况，请充分注意。

Do not operate the Switch when it is exposed to water spray, or when water drops adhere to the Switch surface, or during sudden temperature changes, otherwise water may intrude into the interior of the Switch due to a suction effect.

c) 请避免油污、化学品的附着。否则可能出现使用材质及引起老化。

Prevent the Switch from coming into contact with oil and chemicals. Otherwise, damage to or deterioration of Switch materials may result.

d) 若在含硅粘合剂、油、动物脂肪等环境下使用时，可能因生成氧化硅而产生接触不良。

Do not use the Switch in areas where it is exposed to silicon adhesives, oil, or grease, otherwise faulty contact may result due to the generation of silicon oxide

7. 凸轮挡块操作 Side-actuated (Cam/Dog) Operation

当通过凸轮挡块进行操作时，操作速度、操作频度、按钮按下程度、凸轮挡块的材质以及形状都会影响开关的耐久性，请务必进行事先时机确认。

When using a cam or dog to operate the Switch, factors such as the operating speed, operating frequency, push-button indentation, and material and shape of the cam or dog will affect the durability of the Switch. Confirm performance specifications under actual operation conditions before using the Switch in applications.

8. 正确的使用方法 Correct Use:

(1) 安装 Mounting

A. 开关的安装、拆卸和配线作业以及维护检查时，请务必断开电源。否则会引起触电和烧损。

Turn OFF the power supply before mounting or removing the Switch, wiring, or performing maintenance or inspection. Failure to do so may result in electric shock or burning.

B. 带杆型的固定应采用热固定或压入固定。压入固定时柱杆的对侧设置导杆防止脱落及参差不齐。

For models with posts, secure the posts by thermal caulking or by pressing into an attached device. When pressed into an attached device, provide guides on the opposite ends of the posts to ensure that they do not fall out or rattle.

C. 开关请安装在平面上。如果安装面凹凸不平，可能导致开关歪斜、动作失常和外壳破损。

Mount the Switch onto a flat surface. Mounting on an uneven surface may cause deformation of the Switch, resulting in faulty operation or damage.

(2) 操作行程的设定 Operating Body

操作体应选用摩擦电阻较小的材质。另外，操作体应选用不影响密封胶的形状，否则可能导致按钮破损及密封性能恶化。

Use an operating body with low frictional resistance and of a shape that will not interfere with the sealing rubber, otherwise the plunger may be damaged or the sealing may deteriorate.

(3) 有关使用 Handling

使用中注意不要损坏按钮开关的密封橡胶。

Do not handle the Switch in a way that may cause damage to the sealing rubber.

不要如图所示对端子方面加负重，在摆杆的动作方向以外，请勿向如下图所示的方向施加负重否则可能导致开关破损或引起故障。When handling the Switch, ensure that pressure is not applied to the posts in the directions shown in the following diagram. Also, ensure that uneven pressure or pressure in a direction other than the operating direction is not applied to the Actuator as shown in the following diagram. Otherwise, the post, Actuator, or Switch may be damaged, or the service life may be reduced.

产品型号 Item. #	G303U-130W00A1	说明 Description	微动开关 Micro Switch	版本 Version	A0
页 码 Page	第 9 页 9 of 10		日期 Date	2019-01-26	

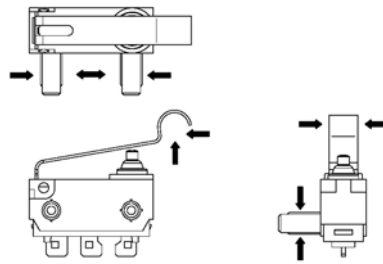

(4) 导线型的配线 Wiring Molded Lead Wire Models

布线时应注意不要出现外力施加于导线引出部位直接进行弯曲等现象。

When wiring molded lead wire models, ensure that there is no weight on the wire or that there are no sharp bends near the parts where the wire is drawn out. Otherwise, damage to the Switch or deterioration in the sealing may result.

(5) 微小负载型中的使用 Using Micro Loads

即使在使用领域范围内进行的使用，也可能因为负载产生的浪涌电流，出现耐久性下降。可根据需要插入接点保护回路。

Even when using micro load models within the operating range, inrush currents or surges may decrease the life expectancy of the Switch. Therefore, insert a contact protection circuit where necessary.

9. 其它 Others:

请特别注意严格遵守以下的禁止事项及注意事项 Please take good care to comply with the following guidelines:

(1) 关于火灾，冒烟的禁止事项 The prohibited practices where there is fire and fume:

A. 超过额定负荷使用时，有发生火灾的可能性，故请勿超负荷使用。

It might catch fire if the rating exceeds the specifications. Never use the switch beyond the rating.

B. 如果有误使用、异常使用等有可能超过额定电流的话，请采取对策. 如:通过设置保护电路等切断电流。

If the rating may exceed due to some abuse or abnormal usage, please take protective measures such as protective circuit to shut down the circuit.

(2) 对于追求安全性产品的注意事项 Precautions to the products requiring special safety:

A. 对于产品品质我司以期万全，但有可能发生寿命等故障形式，如性能劣化、短路、常开等。因此，在设计追求安全性产品的时候：“对于零件单一故障，产品会出现什么故障”。请进行事前检讨。

Though we are confident in switch quality, we can't deny the possibility that there could be failure due to inferior performance, short or open circuit. Therefore, when designing the product requiring special safety, please verify in advance what effects would show on your product in case the switch alone may fail.

B. 准备保护电路保护装置的系统以谋求安全。

Prepare the system with protective circuit and protective devices for safety purposes.

C. 准备安全备用电路，使单一的故障不会导致整体系统的失效，以确保安全性。

Prepare safety standby circuit to preclude the whole system failure that may result from specific failure.

(3) 开关安装时使用 M3.0 的螺钉和平型垫圈，建议使用带扭矩刻度的螺丝刀，扭矩范围 0.15-0.20N.cm(1.5-2.0Kgf.cm)。

Use M3.0 mounting screws with plane washers to securely mount the switch. Tighten the screws to a torque of 0.15 to 0.20N.cm(1.5 to 2.0 Kgf.cm).

(4) 操作件位置的设置以超行程(OT 值)的 70%-90%为适宜。

Make sure that the operating stroke is 70% to 90% of the rated OT distance .

产品型号 Item. #	G303U-130W00A1	说明 Description	微动开关 Micro Switch	版本 Version	A0
页 码 Page	第 10 页 10 of 10		日期 Date	2019-01-26	

(5) 操作件的容许操作速度 1~500mm/Sec. 避免施加冲击载荷.

The allowance operating speed of operation piece should be at 1~500mm/Sec.

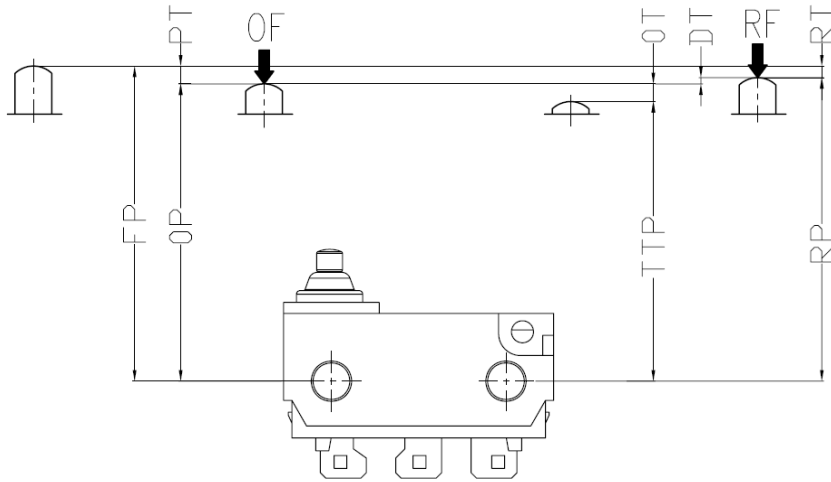

OF :Operating Force

PT :Pre Travel

RF :Release Force

TTP:Total Travel Position

OP :Operating Position

RP :Release Position

FP :Free Position

DT :Differential Travel

OT :Over Travel

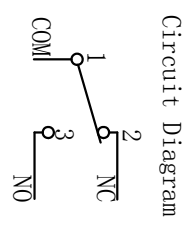
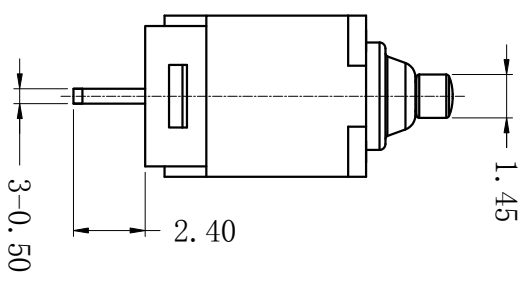
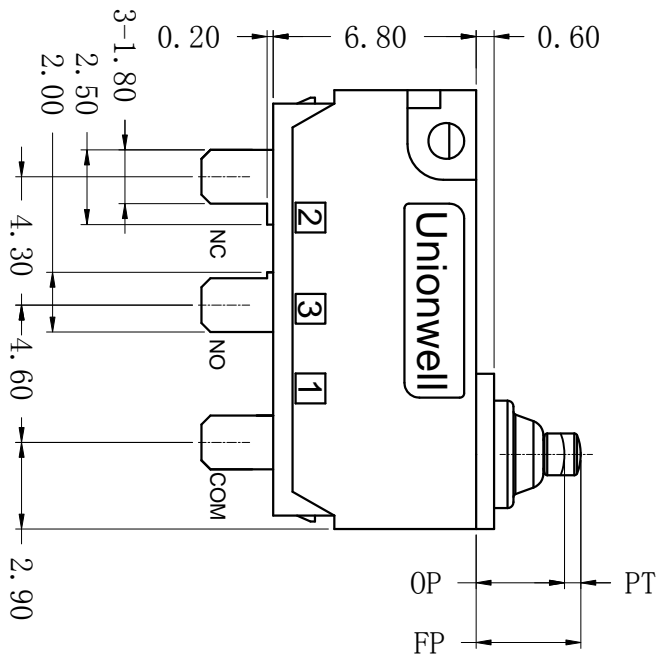
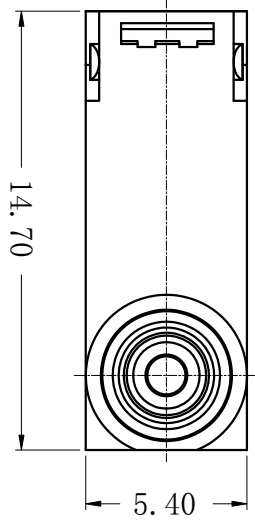

CHARACTERISTICS

Operating Force:	130gf Max.
Release Force:	13gf Min.
Operation Position:	3.05±0.20mm
Pre Travel:	0.80mm Max.
Differential Travel:	0.20mm Max.
Over Travel:	0.80mm Min.

ELECTRICAL DATA

CONTACT ARRANGEMENT	SWITCH SEALING	TERMINALS
S.P.D. T	IP67	IP00
Ratings		
0.1A 48VDC 125/250VAC		
3A 12VDC		
μ40T85 1E5		

REV	REF	DESCRIPTION	DMN. BY	DATE
-----	-----	-------------	---------	------

TITLE	G3 SERIES MICRO SWITCH	PAGE	1/1	VERSION	REV	A0	
MODEL	G303	DRAWING	Jiahui Xu	CHK. BY	Mao	APP. BY	Luke Lu
PART NO.	G303U-130W00A1	DATE	2019-01-26	DATE	2019-01-26	DATE	2019-01-26

TOLERANCES UNLESS OTHERWISE STATED			
DIMENSION	ANGLE	SCALE	UNIT
±0.40	±2°	1:1	mm

HUIZHOU GREENTECH ELECTRONICS CO., LTD.			
---	--	--	--



HUIZHOU GREENTECH ELECTRONICS CO., LTD.

